

skyfens

www.skyfens.pl



2026

ROOF WINDOWS - HATCHES - ROLLER SHUTTERS - AWNINGS - ACCESSORIES



ABOUT US

Skyfens is a leading manufacturer of roof windows in Poland – we focus on combining modern design, functionality and high performance. The brand's solutions are designed with comfort, energy efficiency and long-term reliability in mind, meeting the needs of modern construction.

Skyfens manufactures roof windows of **SUPRO** and **Skylight** brands, which are based on the innovative concept of PVC profile and fitting system acknowledged by a patent clearance test and an application submitted at the European Patent Office. Our roof window manufacturing factory was established in 2008 in Lublin and this city is still our home.

150 There are up to **150** windows manufactured daily.

We have been operating for over **17** years in the roof window market. **17**



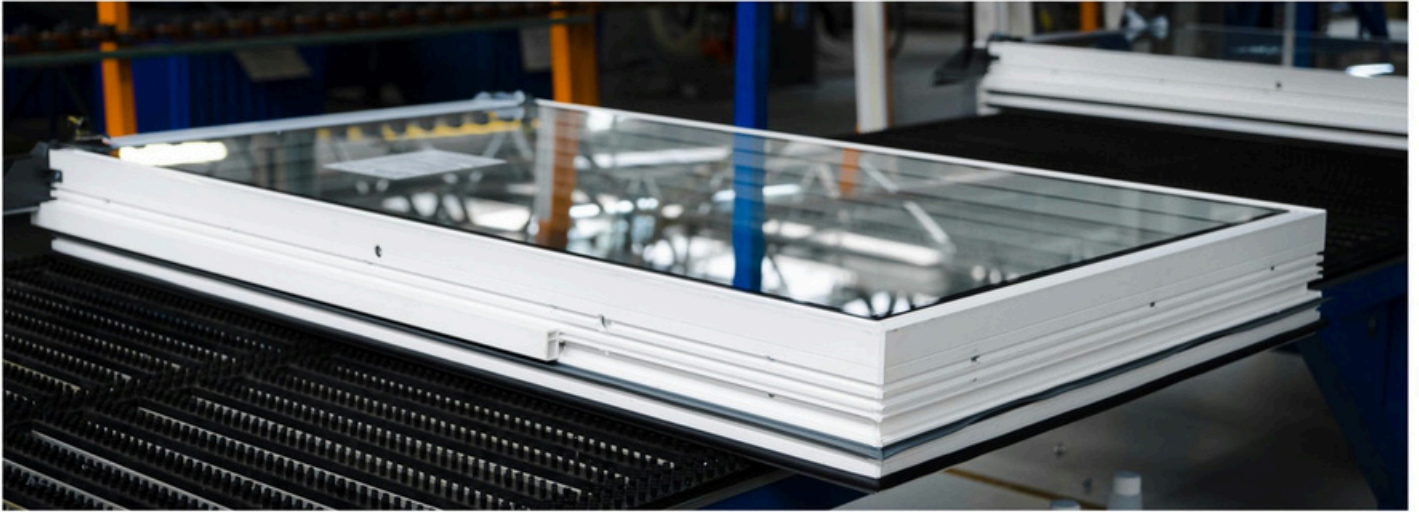

WHY SKYFENS ROOF WINDOWS ARE THE PERFECT CHOICE

✓ ENERGY EFFICIENCY:

- Energy-efficient 2 and 3-glazing package
- Pack of four special gaskets
- TGI Spacer warm frame

✓ QUALITY:

- **Skyfens** windows are made of PVC, reinforced with steel cores.
- The **SUPROALU** line has an aluminum profile
- Micro drains

✓ ERGONOMY:

- Raised pivot for **SUPRO** and **SKYLIGHT** or central axis of rotation for **SUPROALU**
- Two micro-tilt positions in the handle
- Gas cylinders
- Three positions for safely locking the window in place

✓ SIMPLE INSTALLATION:

- Window installation in all types of roofing materials
- Use of special mounting brackets
- Specially designed hinges
- Easy installation of flashings



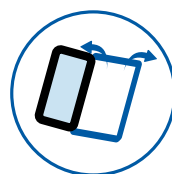
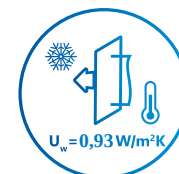
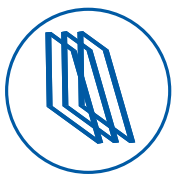
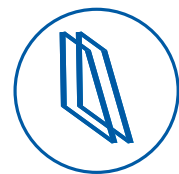
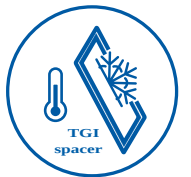

NEW - LAMINATED SAFETY GLASS VSG

2025

Laminated glass (VSG) consists of two panes of glass that are bonded together with a highly tensile and elastic separating layer made of polyvinyl butyral (**PVB**) film.

What does the abbreviation 'VSG' mean?

The term **VSG**, commonly used in Europe and worldwide, is an abbreviation of the German term "**Verbund Sicherheits Glas**", which means '**safety laminated glass**'.

Unlike tempered glass, **VSG** does not shatter into small pieces when damaged, but retains its original shape. If the permissible load is exceeded by impact or pressure, the glass breaks, but the broken pieces of glass remain attached to the intact **PVB** film. This prevents the risk of injury and keeps the glazed area closed.

✔ Advantages of VSG glass:

- increased mechanical strength while maintaining its shape after breaking
- no falling glass fragments when the pane is broken
- VSG panes are one of the safest types of glass available on the market today
- available in a frosted glass version that hides what is behind it

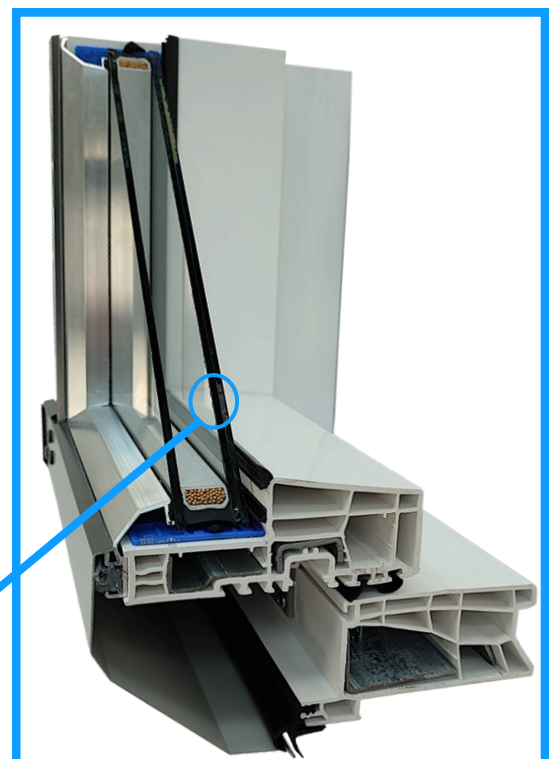

2025

Roof windows

SKYLIGHT ECONOMIC

New 2025 - economical variant in the best possible price, with new build of the frame and sash.

Skylight Economic roof windows stand out above all our products for having the greatest balance between price and quality. Its parameters are sufficient enough for domestic use, but it also incorporates the other pluses of the Skylight range.



SKYLIGHT ECONOMIC



Energy efficiency	<ul style="list-style-type: none"> 2-pane package straight classic PVC profile U_w=1,4 W/m²K
Material	<ul style="list-style-type: none"> lead-free PVC steel reinforcement
Axis of rotation	<ul style="list-style-type: none"> elevated (3/4 window)
Opening	<ul style="list-style-type: none"> manual
Handle	<ul style="list-style-type: none"> mounted on the bottom 2 positions of passive ventilation

Technical data:

Window U-value	Glazing U-value	Acoustic insulation	Air permeability	Water tightness class	Wind load resistance
1,4 W/m ² K	1,1 W/m ² K	30 dB	class No. 3	class No. E1050	class No. C3

- **The new improved profile** combined with a 2-glazed package guarantees a balanced balance of heat gain and loss. U_w coefficient of 1.4 W/m²K.
- **Long-lasting durability.** Aesthetically pleasing, age-resistant, insensitive to moisture and temperature changes PVC, ideal for use in any room of your home.
- **The raised 3/4 pivot** increases visibility from the window and free access.
- **Design.** The window with a simple classic profile will perfectly illuminate interiors of any style.
- **The proprietary, patented fitting system** guarantees full stability of the sash in both the tilt, open and pivot functions while maintaining absolute safety.
- **The system of four gaskets** resistant to low temperatures ensures perfect tightness of the Skylight roof window.
- **Can be installed on roofs** with pitches from **15 to 70 degrees**.
- **Easier replacement of the** glazing unit due to "frontal" installation
- **Using a spring from Skylight** with a **Supro** frame - a balance between price and quality.
- **The external reinforcement of the roof window** protects the hardware from the weather and improves the sealing of the frame-sash connection.
- **Shock-absorbing fitting** does not require any adjustment.
- **No special maintenance is required.** Care is limited to window cleaning.
- **Convenient position for washing** the window - turning the window up to 120 degrees .

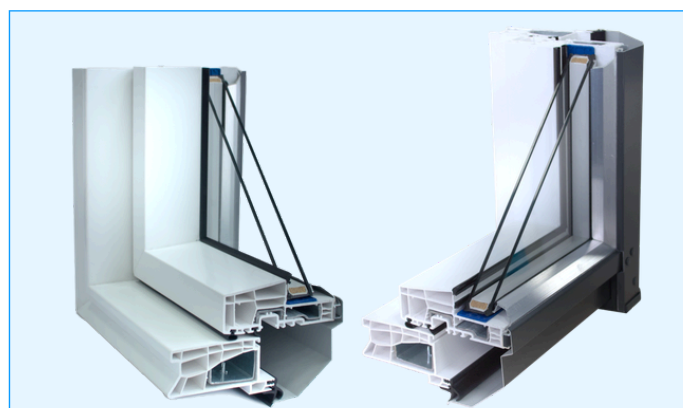

Standard window dimensions:

5/7	5/9	5/11	6/9	6/11	6/14	7/9	7/11	7/14	7/16	9/11	9/14	11/11	11/14
550x780	550x980	550x1180	660x980	660x1180	660x1400	780x980	780x1180	780x1400	780x1600	940x1180	940x1400	1140x1180	1140x1400

We offer the option of bespoke roof windows in any size between our smallest and largest standard model, ensuring a perfect fit for individual projects.

SKYLIGHT

A standard choice of a PCV window for the ideal balance between price and quality. **Skylight** roof windows are distinguished above all by their attractive, slim appearance with straight lines.



SKYLIGHT



Energy efficiency	<ul style="list-style-type: none"> 2-pane package straight classic PVC profile Uw=1,4 W/m²K
Material	<ul style="list-style-type: none"> lead-free PVC steel reinforcement
Axis of rotation	<ul style="list-style-type: none"> elevated (3/4 window)
Opening	<ul style="list-style-type: none"> manual
Handle	<ul style="list-style-type: none"> mounted on the bottom 1 position of passive ventilation

Technical data:

Window U-value	Glazing U-value	Acoustic insulation	Air permeability	Water tightness class	Wind load resistance
1,4 W/m²K	1,1 W/m²K	30 dB	class No. 3	class No. E1050	class No. C3

- **The straight classic profile**, in combination with the 2-pane package, guarantees the sustainable balance of thermal energy acquisition and loss. $U_w = 1,4 \text{ W/m}^2\text{K}$.
- **Longer lifespan**. Aesthetic PVC, resistant to ageing, not sensitive to moisture and temperature changes, ideal for every room at your home.
- **3/4 elevated axis of rotation** improves visibility from the window and easy access.
- **Design**. This window with the original rounded profile will satisfy all the designing requirements.
- **Original patented system of fittings** guarantees full sash stability both in the half-open function, open function and rotational function with the maximum safety.
- **A package of four seals** resistant to low temperatures ensures the perfect tightness of Skylight roof window.
- **Possible installation** on roofs with an **angle of inclination of 15 to 70 degrees**.
- **The external roof window flashing** protects fittings against atmospheric conditions and improves the sealing of the casing-sash connection.
- **Shock absorption fitting** does not need any adjustment.
- **No special maintenance treatment required**. It needs only regular washing.
- **A comfortable position for washing** the external side of the window - sash rotation by 120° .

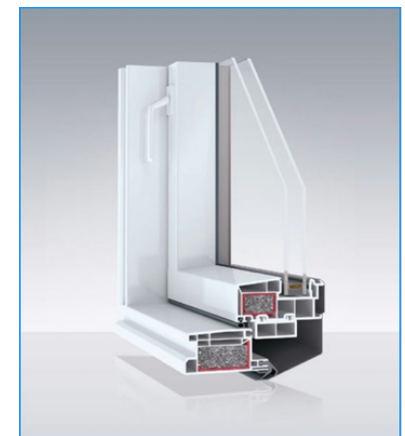

Standard window dimensions:

5/7	5/9	5/11	6/9	6/11	6/14	7/9	7/11	7/14	7/16	9/11	9/14	11/11	11/14
550x780	550x980	550x1180	660x980	660x1180	660x1400	780x980	780x1180	780x1400	780x1600	940x1180	940x1400	1140x1180	1140x1400

We offer the option of bespoke roof windows in any size between our smallest and largest standard model, ensuring a perfect fit for individual projects.

SKYLIGHT PREMIUM

Skylight Premium roof windows are characterised by their original, rounded profile geometry. Thermal transmittance of the window $U_w=1,4W/m^2K$.



SKYLIGHT PREMIUM



Energy efficiency	<ul style="list-style-type: none"> 2-pane package original, rounded profile Uw=1,4 W/m²K
Material	<ul style="list-style-type: none"> lead-free PVC steel reinforcement
Axis of rotation	<ul style="list-style-type: none"> elevated (3/4 window)
Opening	<ul style="list-style-type: none"> manual
Handle	<ul style="list-style-type: none"> mounted on the bottom 1 position of passive ventilation

Technical data:

Window U-value	Glazing U-value	Acoustic insulation	Air permeability	Water tightness class	Wind load resistance
1,4 W/m²K	1,1 W/m²K	30 dB	class No. 4	class No. E1200	class No. C3

- **The unique rounded profile**, in combination with the 2-pane package, guarantees the sustainable balance of thermal energy acquisition and loss. Uw = 1,4 W/m²K.
- **Longer lifespan.** Aesthetic PVC, resistant to ageing, not sensitive to moisture and temperature changes, ideal for every room at your home.
- **3/4 elevated axis of rotation** improves visibility from the window and easy access.
- **Design.** This window with the original rounded profile will satisfy all the designing requirements.
- **Original patented system of fittings** guarantees full sash stability both in the half-open function, open function and rotational function with the maximum safety.
- **A package of four seals** resistant to low temperatures ensures the perfect tightness of Skylight roof window.
- **Possible installation** on roofs with an **angle of inclination of 15 to 70 degrees.**
- **The external roof window flashing** protects fittings against atmospheric conditions and improves the sealing of the casing-sash connection.
- **Shock absorption fitting** does not need any adjustment. No special maintenance treatment required. It needs only washing.
- **A comfortable position for washing** the external side of the window - sash rotation by 120°.

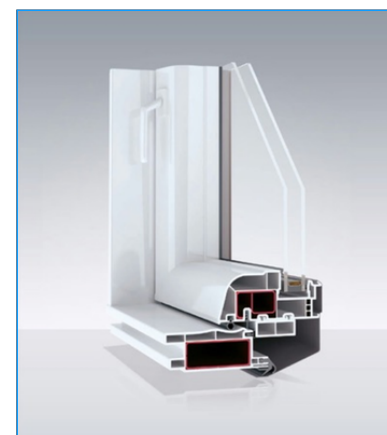

Standard window dimensions:

5/7	5/9	5/11	6/9	6/11	6/14	7/9	7/11	7/14	7/16	9/11	9/14	11/11	11/14
550x780	550x980	550x1180	660x980	660x1180	660x1400	780x980	780x1180	780x1400	780x1600	940x1180	940x1400	1140x1180	1140x1400

We offer the option of bespoke roof windows in any size between our smallest and largest standard model, ensuring a perfect fit for individual projects.

SKYLIGHT PLUS **TERMO**

Skylight Plus Termo roof windows are a combination of the new simple profile and the proven 2-pane package including a new warm frame. The U_w thermal coefficient is at $1,3 \text{ W/m}^2\text{K}$.



SKYLIGHT PLUS TERMO



Energy efficiency	<ul style="list-style-type: none"> 2-glazed package simple classic profile parameter $U_w=1,3 \text{ W/m}^2\text{K}$
Material	<ul style="list-style-type: none"> lead-free PVC steel reinforcements
Axis of rotation	<ul style="list-style-type: none"> raised (3/4 window)
Opening	<ul style="list-style-type: none"> manual assisted by gas actuators
Handle	<ul style="list-style-type: none"> fitted at the bottom one position for passive ventilation

Technical data:

Window U-value	Glazing U-value	Acoustic insulation	Air permeability	Water tightness class	Wind load resistance
1,3 W/m ² K	1,1 W/m ² K	31 dB	class 3	class E1200	class C4

- **The new and improved profile** combined with the 2-glazed package guarantees a balanced balance of heat gain and loss. U_w coefficient of 1,3 W/m²K.
- **A package of four special seals** prevents leaks and contributes to a higher level of thermal protection for the window.
- **The raised 3/4 pivot** increases visibility from the window and allows free access to the window space.
- **Easy installation of flanges** thanks to extended grooves in the frame. Angles used increase the adjustment range of the installed window.
- **Safety of use.** The window is equipped with an innovative frame hinge, which increases the safety, durability and functionality of the window for years to come.
- **The package of four low-temperature seals** ensures excellent airtightness of the Skylight Plus Termo roof window.
- **The external cladding of the roof window protects the fittings** from the weather and improves the sealing of the frame-sash connection.
- Mounting the window is compatible with all types of roofs with a pitch of 15-70°.
- **No special maintenance required.** Care is limited to cleaning the windows.
- **Convenient position for cleaning** the exterior side of the window - turning the sash 120°.

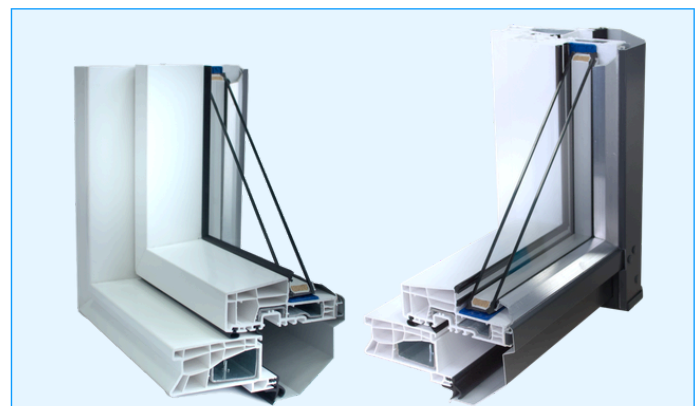

Standard window dimensions:

5/7	5/9	5/11	6/9	6/11	6/14	7/9	7/11	7/14	7/16	9/11	9/14	11/11	11/14
550x780	550x980	550x1180	660x980	660x1180	660x1400	780x980	780x1180	780x1400	780x1600	940x1180	940x1400	1140x1180	1140x1400

We offer the option of bespoke roof windows in any size between our smallest and largest standard model, ensuring a perfect fit for individual projects.

SUPRO TRIPLE

SUPRO Triple roof windows are a combination of a classic straight profile and a 3-pane package. The U_w thermal coefficient is at a level of $1,1 \text{ W/m}^2\text{K}$



SUPRO TRIPLE



Energy efficiency	<ul style="list-style-type: none"> • package of 3 panes • classic straight PVC • profile $U_w=1,1 \text{ W/m}^2\text{K}$
Material	<ul style="list-style-type: none"> • lead-free PVC • steel reinforcement
Axis of rotation	<ul style="list-style-type: none"> • elevated (3/4 window)
Opening	<ul style="list-style-type: none"> • manual with gas springs
Handle	<ul style="list-style-type: none"> • mounted on the bottom • 2 positions of passive ventilation

Technical data:

Window U-value	Glazing U-value	Acoustic insulation	Air permeability	Water tightness class	Wind load resistance
1,1 W/m ² K	0,5 W/m ² K	32 dB	class No. 4	class No. E1200	class No. C4

- **A high energy efficiency level** prevents heat losses at your home in winter and it allows to save on heating. $U_w = 1,1 \text{ W/m}^2\text{K}$.
- **Usage safety.** This window is equipped with an innovative frame hinge which improves the safety, resistance and functionality of windows for long years.
- **An innovative drainage system** solves a problem of the accumulation of water condensation. This new window is equipped with appropriate holes which discharge dampness and condensate outside the window.
- **Design.** This window with a straight classic profile will enlighten perfectly the interior of any style. A silver slat used for finishing the pane package makes SUPRO window underline the modern style of your roof.
- **The elevated axis of rotation** improves visibility from the window and easy access.
- **Simpler servicing of glazing packages.** The front installation of SUPRO window makes it possible to replace the glazing package alone.
- **Possible installation** on roofs with an **angle of inclination of 15 to 70°.**
- **The easy opening of the roof window** is ensured by gas springs which make the position stable.
- **Longer lifespan.** Aesthetic PVC, resistant to ageing, not sensitive to moisture and temperature changes, ideal for every room at your home.
- **Easier installation of flanges** owing to widened grooves in the frame. The angle sections increase the adjustment range of the window being mounted.



Standard window dimensions:

5/7	5/9	5/11	6/9	6/11	6/14	7/9	7/11	7/14	7/16	9/11	9/14	11/11	11/14
550x780	550x980	550x1180	660x980	660x1180	660x1400	780x980	780x1180	780x1400	780x1600	940x1180	940x1400	1140x1180	1140x1400

We offer the option of bespoke roof windows in any size between our smallest and largest standard model, ensuring a perfect fit for individual projects.

SUPRO TRIPLE **TERMO**

Skyfens **SUPRO Triple Termo** roof windows feature a high level of energy efficiency for your home thanks to the combination of a 3-pane package with a TGI Spacer warm spacer.



SUPRO TRIPLE TERMO

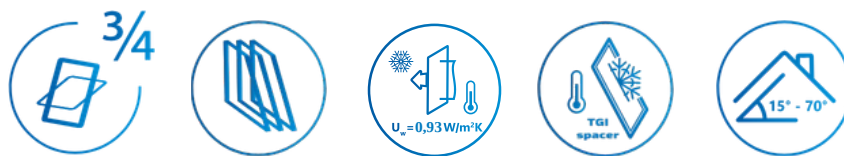

Energy efficiency	<ul style="list-style-type: none"> 3-glazed package with TGI Spacer warm frame simple classic PVC profile parameter $U_w=0,93 \text{ W/m}^2\text{K}$
Material	<ul style="list-style-type: none"> lead-free PVC steel reinforcements
Axis of rotation	<ul style="list-style-type: none"> elevated (3/4 window)
Opening	<ul style="list-style-type: none"> manual assisted by gas cylinders
Handle	<ul style="list-style-type: none"> mounted on the bottom 2 positions of passive ventilation

Technical data:

Window U-value	Glazing U-value	Acoustic insulation	Air permeability	Water tightness class	Wind load resistance
0,93 W/m ² K	0,5 W/m ² K	32 dB	class No. 4	class No. E1200	class No. C4

- **A high energy efficiency level** prevents heat losses at your home in winter and it allows to save on heating. The combination of a 3-pane package with a warm TGI Spacer frame reduces U_w to 0,93 W/m²K.
- **Usage safety.** This window is equipped with an innovative frame hinge which improves the safety, resistance and functionality of windows for long years.
- **An innovative drainage system** solves a problem of the accumulation of water condensation. This new window is equipped with practical holes which discharge dampness and condensate outside the window.
- **Design.** This window with a straight classic profile will beautify the interior all styles. A silver slat used for finishing the pane package makes SUPRO window underline the modern style of your roof.
- **Elevated axis of rotation** improves visibility from the window and allows for easy access.
- **Simpler servicing of glazing packages.** The front installation of SUPRO window makes it possible to replace the glazing package alone.
- **Easy opening of the roof window** ensured by gas springs which help the stability.
- **Longer lifespan.** Aesthetic PVC, resistant to aging, resistant to moisture and temperature changes, ideal for every room at your home.
- **Easier installation of flanges** owing to widened grooves in the frame. The angle sections increase the adjustment range of the window being mounted.
- **Possible installation** on roofs with an angle of inclination of **15 to 70 degrees.**



Standard window dimensions:

5/7	5/9	5/11	6/9	6/11	6/14	7/9	7/11	7/14	7/16	9/11	9/14	11/11	11/14
550x780	550x980	550x1180	660x980	660x1180	660x1400	780x980	780x1180	780x1400	780x1600	940x1180	940x1400	1140x1180	1140x1400

We offer the option of bespoke roof windows in any size between our smallest and largest standard model, ensuring a perfect fit for individual projects.

SUPROALU

Aluminium type window for those who demand the highest quality

SUPROALU aluminium roof windows represent an innovative approach to design and functionality, aimed at customers seeking premium products.



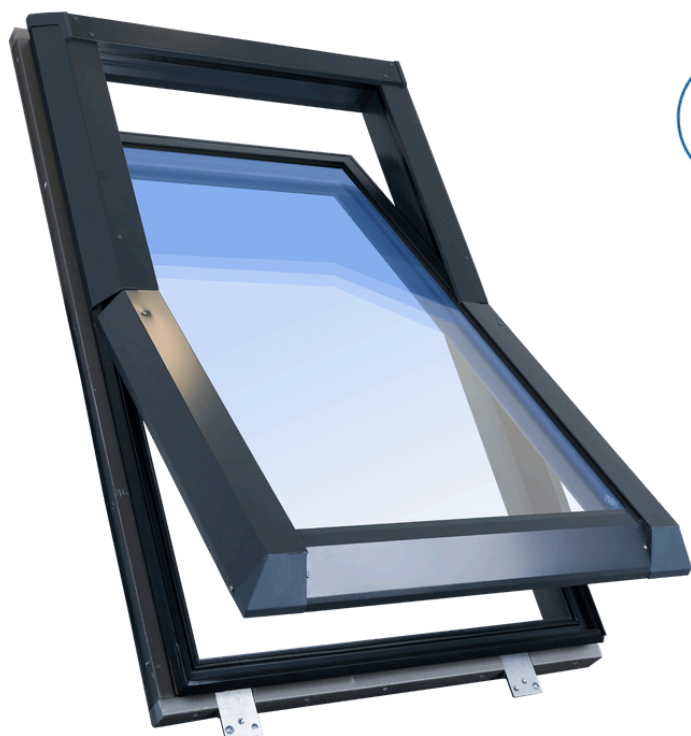

Energy efficiency	<ul style="list-style-type: none"> 3-glazed package rounded profile U_w=1,0 W/m²K parameter
Material	<ul style="list-style-type: none"> aluminium
Axis of rotation	<ul style="list-style-type: none"> central (1/2 window)
Opening	<ul style="list-style-type: none"> manual
Handle	<ul style="list-style-type: none"> fitted at the bottom one position for passive ventilation

Technical data:

Window U-value	Glazing U-value	Acoustic insulation	Air permeability	Water tightness class	Wind load resistance
1,0 W/m ² K	0,7 W/m ² K	32 dB	class 4	class E1200	C5/B5

- Modern and lightweight construction** of multi-chamber aluminium profiles with termite spacers, allowing for above-standard roof window surface dimensions.
- Glazing package with external toughened glass** of 4 mm and internal thermal insulation glass.
- TGI warm frame** to improve the thermal properties of the window. Insulation insert in the window frame and sash to provide continuous protection against heat loss.
- External frame insulation** made of EPS material as standard.
- Excellent window tightness** ensured by a system of four gaskets resistant to UV radiation and low temperatures.
- Central pivot.**
- Can be fitted** on roofs with pitches from **15 to 80 degrees**.
- Special hinge design** for quick and easy installation and free post-installation adjustment.
- Possibility of painting the aluminium profiles** in the full range of RAL colours, anodised and colours imitating the structure of wood.
- Possible realisation of projects **above standard sizes** on individual orders.

Window colours available:

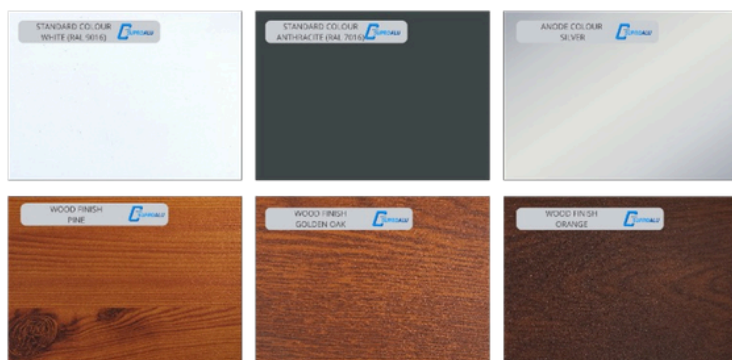

Frame cross-section:

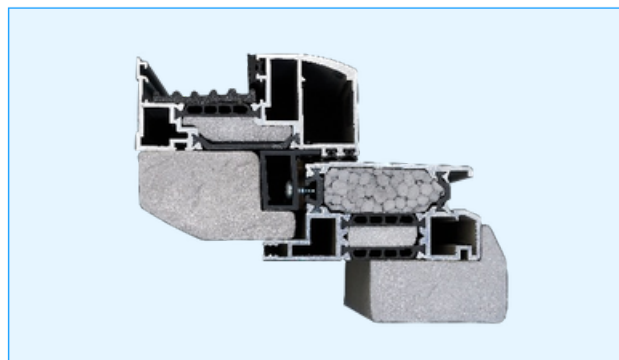

Standard dimensions of SUPROALU windows:

5/7	5/9	5/11	6/9	6/11	6/14	7/9	7/11	7/14	7/16	9/11	9/14	9/16	09/18	11/11	11/14	13/14	13/16
550x780	550x980	550x1180	660x980	660x1180	660x1400	780x980	780x1180	780x1400	780x1600	940x1180	940x1400	940x1600	940x1800	1140x1180	1140x1400	1340x1400	1340x1600

We offer the option of bespoke roof windows in any size between our smallest and largest standard model, ensuring a perfect fit for individual projects.

Roof hatches



SKYLIGHT LOFT

Economical roof hatch for versatile use

Skylight Loft roof hatches feature an aesthetically pleasing and simple profile that gives the construction an attractive and modern look. They provide easy and safe access to the roof.

SKYLIGHT LOFT

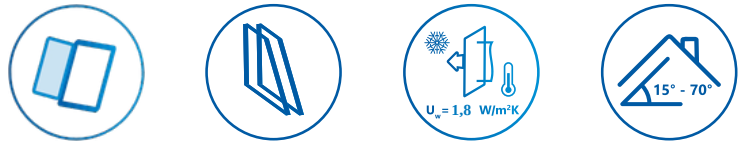

Energy efficiency	<ul style="list-style-type: none"> • 2-pane glass package • classic straight PVC profile • $U_w=1,8 \text{ W/m}^2\text{K}$
Material	<ul style="list-style-type: none"> • lead-free PVC • steel reinforcement
Opening	<ul style="list-style-type: none"> • manual-lateral • possibility of opening to the right or left side of the roof
Handle	<ul style="list-style-type: none"> • 1 position of passive ventilation

Technical data:

Window U-value	Glazing U-value	Acoustic insulation	Air permeability	Water tightness class	Wind load resistance
1,8 W/m ² K	1,1 W/m ² K	30 dB	class No. 4	class No. E1200	class No. C3

- **Roof hatches have high thermal insulation** parameters dedicated to rooms which are not heated but it does not exclude their use in heated rooms. $U_w = 1,8 \text{ W/m}^2\text{K}$.
- **Long lifespan.** Aesthetic PVC, resistant to ageing, not sensitive to moisture and temperature changes, ideal for every room at your home.
- **Functionality.** Owing to the possibility of opening to the right or to the left of the roof, they ensure easy exit to the roof.
- **The roof hatch has an opening/closing lock** which ensures an opened position up to 90° that allows for safe access to the roof.
- **Possible installation** on roofs with an **angle of inclination of 15 to 70 degrees.**
- **The mounted handle** allows for opening the roof hatch to the airing position.
- **A system of three seals** resistant to low temperatures ensures the perfect tightness of Skylight roof hatch.
- **Design.** This roof hatch with a straight classic profile will enlighten perfectly the interior of any style.
- **No special maintenance treatment required.** It needs only washing.

Standard roof hatches dimensions:

4/7	5/7	5/9	6/9	7/9
450x730	550x780	550x980	660x980	780x980

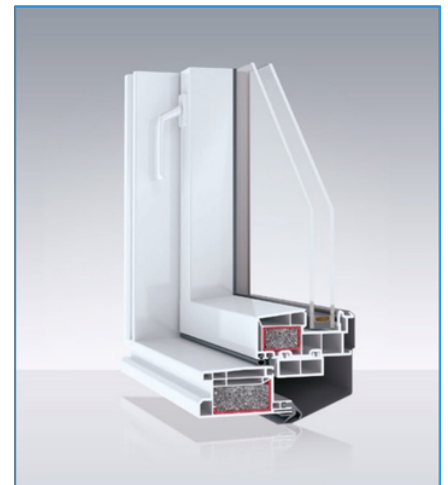

Roof hatches



SKYLIGHT LOFT **TERMO**

Skylight Loft Termo roof hatches are characterised by a unique yet simple and straight geometry of the insulated profile, but with an added thermal insulation. They provide easy and safe access to the roof.

SKYLIGHT LOFT TERMO



Energy efficiency	<ul style="list-style-type: none"> • package of 2 panes with a warm TGI Spacer frame • original rounded thermally insulated profile • $U_w=1,5 \text{ W/m}^2\text{K}$
Material	<ul style="list-style-type: none"> • lead-free PVC • steel reinforcement
Opening	<ul style="list-style-type: none"> • manual-lateral • possibility of opening to the right or left side of the roof
Handle	<ul style="list-style-type: none"> • 1 position of passive ventilation

Window U-value	Glazing U-value	Acoustic insulation	Air permeability	Water tightness class	Wind load resistance
1,5 W/m ² K	1,0 W/m ² K	30 dB	class No. 4	class No. E1200	class No. C3

- **Roof hatches have high thermal insulation** parameters dedicated to rooms which are not heated but it does not exclude their use in heated rooms. $U_w = 1,5 \text{ W/m}^2\text{K}$.
- **Long lifespan.** Aesthetic PVC, resistant to ageing, not sensitive to moisture and temperature changes, ideal for every room at your home.
- **Functionality.** Owing to the possibility of opening to the right or to the left of the roof, they ensure easy exit to the roof.
- **The roof hatch has an opening/closing lock** which ensures an opened position up to 90° that allows for safe access to the roof.
- **The mounted handle** allows for opening the roof hatch to the airing position.
- **Possible installation** on roofs with an **angle of inclination of 15 to 70 degrees.**
- **A system of three seals** resistant to low temperatures ensures the perfect tightness of Skylight roof hatch.
- **Design.** This roof hatch with the original simple, insulated profile will satisfy all the designing requirements.
- **No special maintenance treatment required.** It needs only washing.

Standard roof hatches dimensions:

4/7	5/7	5/9	6/9	7/9
450x730	550x780	550x980	660x980	780x980





SKYLIGHT LOFT PLUS **TERMO**

Skylight Loft PLUS Termo roof hatches provide great thermal insulation thanks to a double-glazed package with a warm frame ($U_w 1,4 \text{ W/m}^2\text{K}$). It is the ideal solution for those looking for a balance between cost and energy efficiency in heated and unheated rooms.

SKYLIGHT LOFT PLUS TERMO



Energy efficiency	<ul style="list-style-type: none"> 2-glazed package with TGI Spacer warm frame simple classic profile parameter $U_w=1,4 \text{ W/m}^2\text{K}$
Material	<ul style="list-style-type: none"> lead-free PVC steel reinforcements
Opening	<ul style="list-style-type: none"> manual to the side sizes 6/X and 7/X with gas spring actuators can be opened to the right or to the left side of the roof
Handle	<ul style="list-style-type: none"> two passive ventilation positions

Technical data:

Coefficient U_w	Coefficient U_g	Sound insulation	Air permeability	Watertightness class	Wind load resistance
1,4 $\text{W/m}^2\text{K}$	0,5 $\text{W/m}^2\text{K}$	31 dB	class 3	class E1200	class C5

- SkylightPLUS Loft Termo Roof Windows** – Equipped with a double-glazed package and a warm frame, achieving excellent thermal insulation parameters with a U-value of 1,4 $\text{W/m}^2\text{K}$. This is an ideal solution for those seeking a balance between cost and energy efficiency in both heated and unheated spaces.
- Innovative Hinge.** Enhanced safety and functionality thanks to the new hinge, which not only increases durability but also allows for smooth adjustment of the window sash, ensuring a perfect fit.
- Additional Dimension Options** – We have introduced new, large sizes for roof windows: 6/11 and 7/11, which meet the needs of projects requiring larger installation solutions and provide additional light space.
- Accessibility and Ergonomics** – The roof windows can be opened to the right or left, facilitating roof access. Side opening with a lock ensures that the sash remains open at a 90-degree angle.
- Innovative Opening Mechanisms** – For sizes 5/7 and 5/9, a casement mechanism is used, which facilitates manual opening and closing operations. In larger sizes 6/9, 6/11, 7/9, and 7/11, double gas struts with a damping function are installed, ensuring smoothness and safety in use.
- Optimal Protection Against External Conditions** thanks to three seals resistant to low temperatures, which provide maximum tightness of the roof hatch.
- Aesthetics and Easy Maintenance** – The roof window has a classic design that fits well with various interior styles and requires minimal maintenance, limited to occasional washing.
- Passive Ventilation** – The handle allows the roof hatch to be cracked open in two positions, enabling effective and adjustable ventilation.
- Installation on Various Roof Slopes and Coverings** – The roof window can be installed on roofs with a slope of 15 to 70 degrees and on any type of roof covering, offering wide compatibility and flexibility in adapting to various roof constructions.

Standard dimensions of the hatches:

5/7*	5/9*	6/9**	6/11**	7/9**	7/11**
550x780	550x980	660x980	660x1180	780x980	780x1180

* dimensions of egress hatches with hinge installed

** dimensions of egress hatches with fitted gas spring assisted opening



Roof hatches



SUPRO LOFT TRIPLE

Supro Loft Triple roof hatches provide good thermal insulation thanks to their triple glazing ($U_w 1,2 \text{ W/m}^2\text{K}$). They are also available in large sizes for better interior lighting. New adjustable hinges and gas struts make installation easier and more comfortable.

SUPRO LOFT TRIPLE



Energy efficiency	<ul style="list-style-type: none"> • 3-glazed package • simple classic profile • parameter $U_w=1,2 \text{ W/m}^2\text{K}$
Material	<ul style="list-style-type: none"> • lead-free PVC • steel reinforcements
Opening	<ul style="list-style-type: none"> • manual to the side • sizes 6/X and 7/X with gas spring actuators • can be opened to the right or to the left side of the roof
Handle	<ul style="list-style-type: none"> • two passive ventilation positions

Technical data:

Coefficient U_w	Coefficient U_g	Sound insulation	Air permeability	Watertightness class	Wind load resistance
1,2 W/m ² K	0,5 W/m ² K	32 dB	class 4	class E1200	class C4

- **SUPRO Loft Triple Roof Hatch** - with a triple glazing package achieving a thermal transmittance coefficient (U_w) of 1,2 W/m²K. It is an ideal choice for both heated and unheated rooms, offering good thermal insulation.
- **Innovative Hinge.** Enhanced safety and functionality thanks to the new hinge, which not only increases durability but also allows for smooth adjustment of the window sash, ensuring a perfect fit.
- **Additional Dimension Options** - We have introduced new, large sizes for roof windows: 6/11 and 7/11, which meet the needs of projects requiring larger installation solutions and provide additional light space.
- **Accessibility and Ergonomics** - The roof windows can be opened to the right or left, facilitating roof access. Side opening with a lock ensures that the sash remains open at a 90-degree angle.
- **Innovative Opening Mechanisms** - For sizes 5/7 and 5/9, a casement mechanism is used, which facilitates manual opening and closing operations. In larger sizes 6/9, 6/11, 7/9, and 7/11, double gas struts with a damping function are installed, ensuring smoothness and safety in use.
- **Optimal Protection Against External Conditions** thanks to three seals resistant to low temperatures, which provide maximum tightness of the roof hatch.
- **Aesthetics and Easy Maintenance** - The roof window has a classic design that fits well with various interior styles and requires minimal maintenance, limited to occasional washing.
- **Passive Ventilation** - The handle allows the roof hatch to be cracked open in two positions, enabling effective and adjustable ventilation.
- **Installation on Various Roof Slopes and Coverings** - The roof window can be installed on roofs with a slope of 15 to 70 degrees and on any type of roof covering, offering wide compatibility and flexibility in adapting to various roof constructions.

Standard dimensions of the hatches:

5/7*	5/9*	6/9**	6/11**	7/9**	7/11**
550x780	550x980	660x980	660x1180	780x980	780x1180

* dimensions of egress hatches with hinge installed

** dimensions of egress hatches with fitted gas spring assisted opening

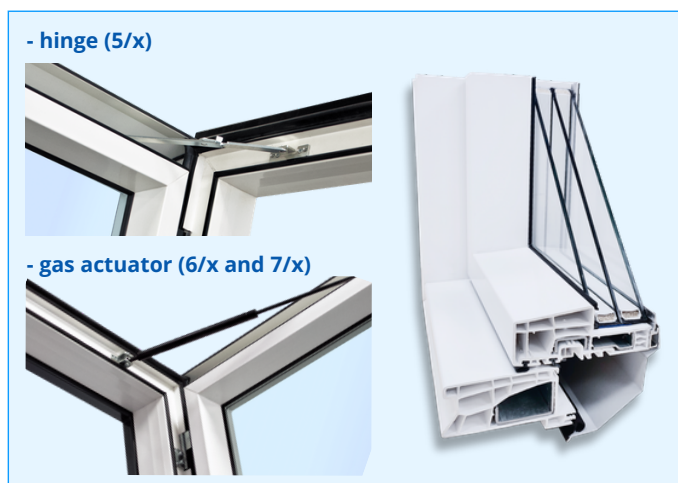



SUPRO LOFT TRIPLE **TERMO**

Supro Loft Triple Termo roof hatches offer excellent thermal insulation thanks to a triple glazing package with a warm frame ($U_w 1,1 \text{ W/m}^2\text{K}$). Ideal for large roof openings, they provide a balance between cost and energy efficiency.

SUPRO LOFT TRIPLE TERMO



Energy efficiency	<ul style="list-style-type: none"> 3-glazed package with TGI Spacer warm frame simple classic profile parameter $U_w=1,1 \text{ W/m}^2\text{K}$
Material	<ul style="list-style-type: none"> Lead-free PVC steel reinforcements
Opening	<ul style="list-style-type: none"> manual to the side sizes 6/X and 7/X with gas spring actuators can be opened to the right or to the left side of the roof
Handle	<ul style="list-style-type: none"> two passive ventilation positions

Technical data:

Coefficient U_w	Coefficient U_g	Sound insulation	Air permeability	Watertightness class	Wind load resistance
1,1 W/m ² K	0,5 W/m ² K	32 dB	class 4	class E1200	class C4

- SUPRO Roof Hatches** with a triple-glazed package and a warm TGI Spacer frame effectively reduce the heat transfer coefficient (U_w) to 1,1 W/m²K. They are ideal for both heated and unheated spaces due to their excellent thermal insulation properties.
- Innovative Hinge.** Enhanced safety and functionality thanks to the new hinge, which not only increases durability but also allows for smooth adjustment of the window sash, ensuring a perfect fit.
- Additional Dimension Options** – We have introduced new, large sizes for roof windows: 6/11 and 7/11, which meet the needs of projects requiring larger installation solutions and provide additional light space.
- Accessibility and Ergonomics** – The roof windows can be opened to the right or left, facilitating roof access. Side opening with a lock ensures that the sash remains open at a 90-degree angle.
- Innovative Opening Mechanisms** – For sizes 5/7 and 5/9, a casement mechanism is used, which facilitates manual opening and closing operations. In larger sizes 6/9, 6/11, 7/9, and 7/11, double gas struts with a damping function are installed, ensuring smoothness and safety in use.
- Optimal Protection Against External Conditions** thanks to three seals resistant to low temperatures, which provide maximum tightness of the roof hatch.
- Aesthetics and Easy Maintenance** – The roof window has a classic design that fits well with various interior styles and requires minimal maintenance, limited to occasional washing.
- Passive Ventilation** – The handle allows the roof hatch to be cracked open in two positions, enabling effective and adjustable ventilation.
- Installation on Various Roof Slopes and Coverings** – The roof window can be installed on roofs with a slope of 15 to 70 degrees and on any type of roof covering, offering wide compatibility and flexibility in adapting to various roof constructions.

Standard dimensions of the hatches:

5/7*	5/9*	6/9**	6/11**	7/9**	7/11**
550x780	550x980	660x980	660x1180	780x980	780x1180

* dimensions of egress hatches with hinge installed

** dimensions of egress hatches with fitted gas spring assisted opening

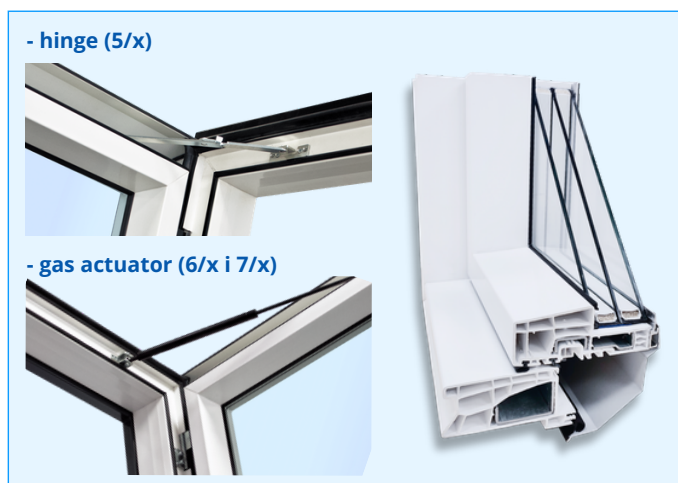

SEALING FLANGES

Sealing flanges made of aluminium sheet with permanently protected polyester paints.

Flange types:

- **F** - flange for **corrugated** roofing (up to a wave height of **3.5 cm**)
- **P** - flange for **flat** roofing
- **M** - modular
 - **MF** - modular for **corrugated** roofing*
 - **MP** - modular for **flat** roofing*
- **K** - elbow flange (for connecting a roof window with a facade window), available also in a modular version.
- Scaled flange
- Flange for **flat roofing + box** (wood + styrofoam)
- Flange for **panel sheet**
- Flange for **renovation** (to replace an old window with select Skyfens windows)

*Special flanges enable the installation of windows side by side or one above another.



Flange for flat roofs



Flange for corrugated roofing



Modular flange



Scaled flange

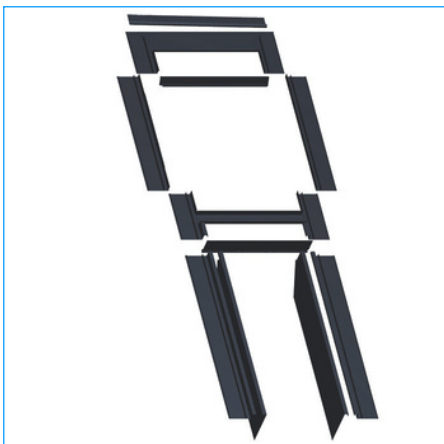

Elbow corrugated "F" and flat "P" flange



Modular corrugated "F" and flat "P" flange

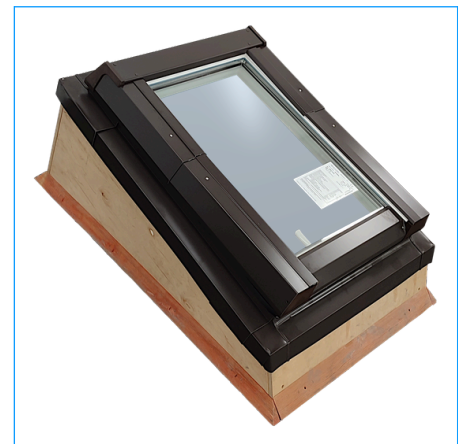

Flange for flat roofing

RENOVI - roof window + renovation flange

RENOVI roof windows complete with renovation flange of an aesthetically pleasing, simple profile geometry fit in with both modern and traditional construction. Windows made of PVC do not require any additional maintenance. The window's raised pivot axis and the handle fixed at the bottom of the window, guarantee ease of use and more space in the room.

The main advantage of renovation windows is the ability to adjust the depth of their installation in the roof slope. This allows us to build a new window on the existing interior wall of the room without disturbing it.

Hence the name - "renovation window".

This has been achieved thanks to the special design of the elements that fasten the frame to the roof slope beams, as well as the special design of the sealing collar, consisting of an upper part tied to the frame and a lower part laying on the roof slope.

Possible windows for use as a renovation set:

- **Skylight Economic**
- **Skylight Plus Termo**
- **Supro Triple**
- **Supro Triple Termo**

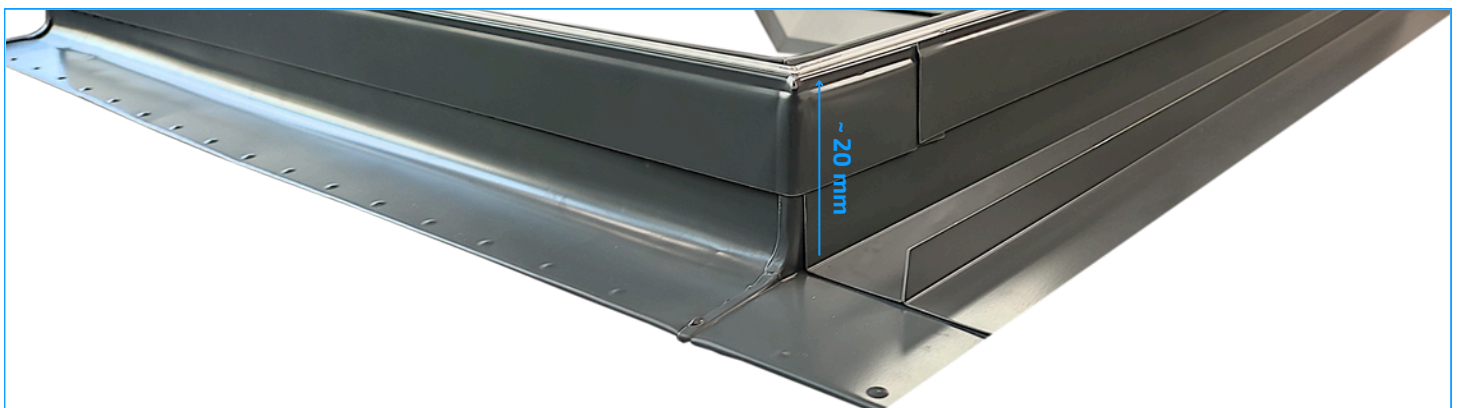
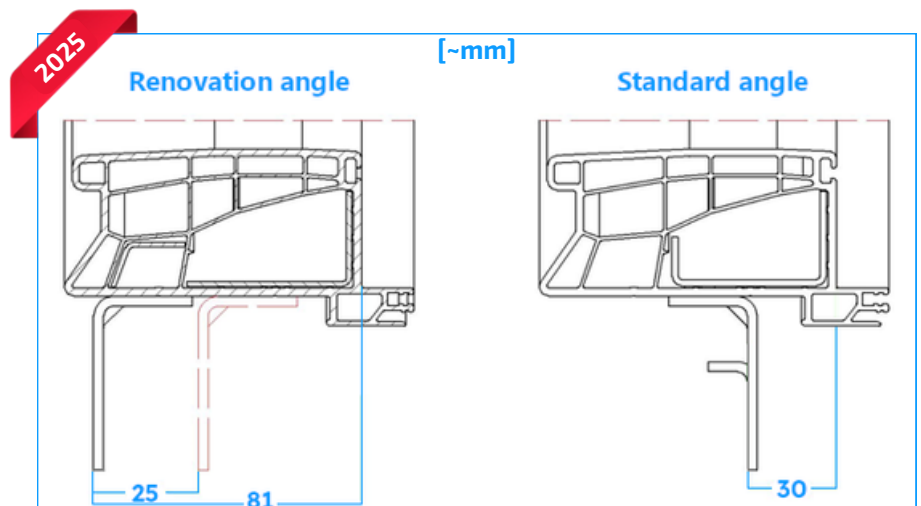

COLOURS

Individualism and aesthetics. The appearance of the Skyfens products combines functionality and beauty. Roof window profiles of the **SUPRO** and **Skylight** lines are made in classic white color. The colors of the cladding and sealing flanges are available in two colors **RAL7043 (anthracite)** and **RAL8019 (brown)**.

Color of the window frame



The colours of flashing and sealing flanges

Standard

RAL 7043

RAL 8019

Examples available upon request:

RAL 7016

RAL 9005

RAL 3009

RAL 9010

Opening handle (optionally with a lock)

SUPRO and **SKYLIGHT** roof windows are fitted with the classic white handle. On special request, we can use a handle with a safety button, which protects the window from being opened, for example by children. A cut-out is provided in each handle slot, allowing the window to be unsealed and the room to be effectively aired. and effective ventilation of the room. **SUPRO** windows have two positions of unsealing, and **SKYLIGHT** have one.



White



SUPRO handle slot



Skylight handle slots

PVC roof windows have three fixed opening positions that guarantee the stability of the sash and safe use in these positions.

Window ventilators

New, warm windows allow not only for heating savings but they also make staying at home more comfortable. This is why proper ventilation is now even more important because it enables eliminating dampness from rooms. In some situations, regular airing may be not enough. A good solution here are windows with integrated intake ventilators.

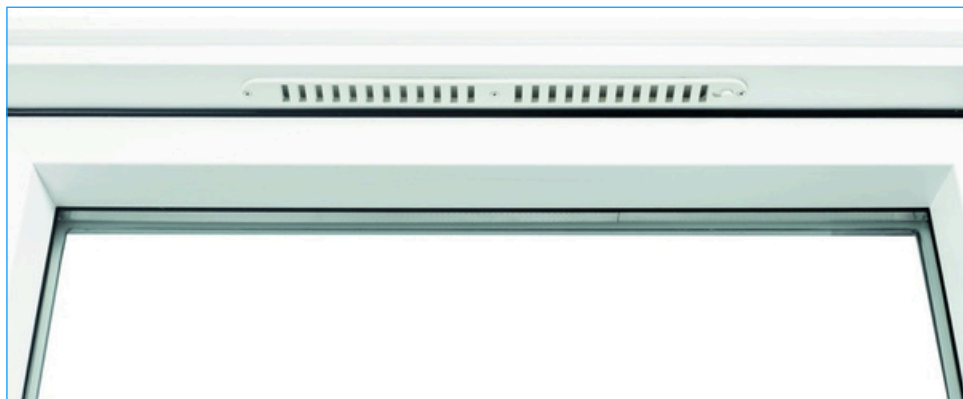

Control units

Window automation control systems enable precise management of window and roof actuators, ensuring full control over ventilation, temperature and building security.

The **TF44R** control unit is a more advanced solution allowing for the connection of a greater number of windows, actuators and sensors when compared to the more economical **RR** control unit



TF44R Control unit

- up to 16 windows
- 4 independent groups
- rain and wind sensor support
- control via wall switch and remote control

RR Control unit

- up to 6 windows
- one group
- compatible with a rain sensor or wall switch
- remote control



Weather sensors

To ensure the window automation control system operates fully and comprehensively, we offer the **RDC/12 rain sensor** (for installation on **both the RR and TF44R** control units) and the **RW wind sensor** (for installation on the **TF44R control unit only**).

The sensors operate with precision, offering a rapid response to changing weather conditions and ensuring the safety and comfort of users.

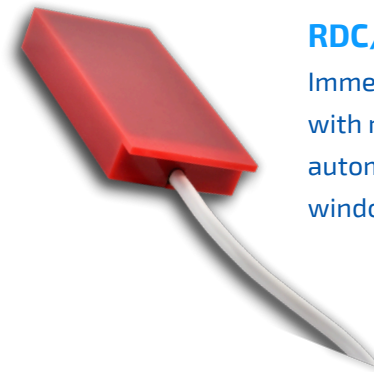

RDC/12 Rain sensor

Immediately detects contact with raindrops and automatically closes the window.

RW Wind sensor

Detects a breeze instantly, and you can easily adjust the sensitivity – **from 5 km/h to 40 km/h**.



TR8 8-channel remote control

This **eight-channel** radio remote control, operating at a frequency of **433.92 MHz**, is designed for the remote control of control units and actuators. It is also convenient to use, thanks to its long range, compact size and magnetic holder.

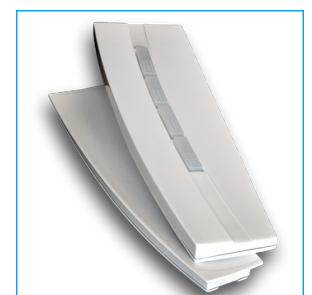

Electric actuators

They guarantee comfortable and automatic window operation. This is a perfect solution for windows mounted in locations with difficult access. A rain sensor which closes the window automatically when rain is detected. It is also possible to equip the window with a wind sensor which closes the window automatically when strong wind is detected. A simple and flexible solution preventing the need for the manual window operation..



Telescopic stick

Telescopic stick for roof windows allows easy and simple control of a window installed at a high height. Available in **160cm**, **180cm** and **200cm versions**.

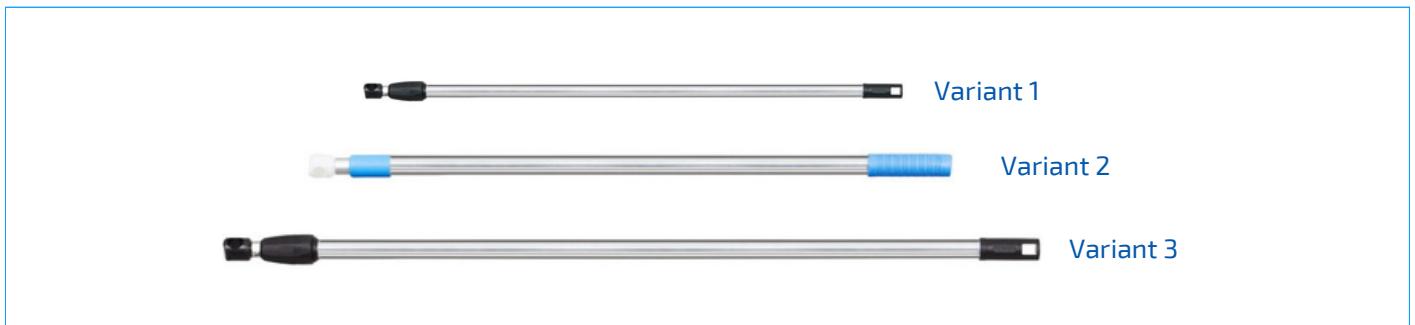

Water permeable membrane SkyDAMP

Made out of a roofing membrane of approximately 150 g/m², three-layer, open diffusion, with excellent vapour permeability. Durable and resistant to aging. Suitable for use on fully boarded roofs.



Valves for window packages used in mountainous areas (>650 m above sea level)

Standard insulating glass units perform well at heights close to where they are manufactured. At high altitudes (> 650 m above sea level), reduced atmospheric pressure can cause significant overpressure in the glass, leading to reduced durability of the glass seal, bulging of the glass and even cracking of the glass. To reduce the pressure in the space between the panes, a special valve is placed in the spacer frame of insulating glass units intended for use in areas above 650 m above sea level. This valve allows for maintaining a specific pressure value and protects against excessive pressure buildup.

Therefore, when placing orders for windows that will be used at altitudes > 650 m above sea level, it is advisable to include clear information about this.

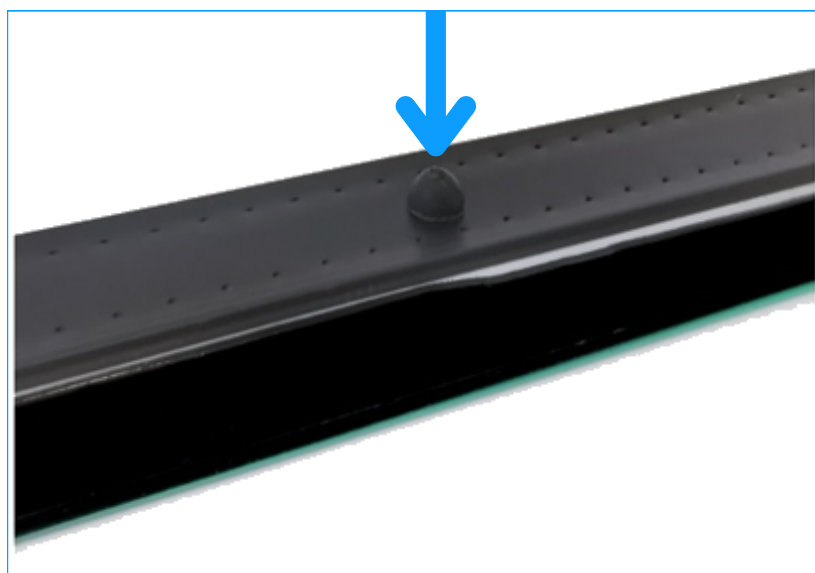

SkyVER roller blinds are a functional and aesthetically pleasing solution for your **SUPRO** and **SKYLIGHT** windows.

Perfectly suited for your roof windows. They are available in both sunshade and blackout versions, guaranteeing protection against excessive heat build-up and a peaceful night's sleep in a darkened room.

Available in a wide range of colours and designs - please visit: www.skyfens.pl/en



- **Cassette system** made of aluminium with aluminium guides
- **Shutters intended for high-pitched roof windows** mounted on the roof sash
- **The spring mechanism** easily allows you to set any position of the roller shutter and allows the fabric to be automatically rolled up into the cassette
- **Invasive installation:** screws



SKYVER INTERIOR ROLLER BLINDS AND PLEATS



Aluminium external shutters, folding and straight fitting for **SUPRO** and **SKYLIGHT** roof windows

The **SkyROLL roller shutter** is the perfect solution designed specifically for those seeking effective protection against light, noise, excessive sunlight and high temperatures in loft spaces. Our roller shutter combines functionality, durability and aesthetics, while providing convenient and easy control.



Key features of SkyROLL roller shutters:

- **Protection from light and temperature:** Our external roller shutter effectively blocks excessive sunlight.
- **Protection against noise:** The robust construction of the roller shutter contributes to a significant reduction in external noise.
- **Privacy:** The external roller shutter for SkyROLL roof windows provides an additional layer of privacy for the occupants of the attic rooms.
- **Durability and weather resistance:** The SkyROLL external roller shutter is made of high-quality aluminium, which guarantees its durability and resistance to weather conditions such as rain, wind and UV rays.
- **Convenient control:** our external roller shutter for roof windows is equipped with a convenient control system, which allows you to easily adjust its position and light inside the room. It can be controlled via a wall button or remote control,
- **Power supply:** Our external roller shutter for roof windows offers two convenient power options - electricity or solar energy.
- **Aesthetic design:** Our external roller shutter has been designed with aesthetics in mind and fits harmoniously with the window. It is available in two colour versions: anthracite and bronze.



SKYROLL EXTERNAL SHUTTER

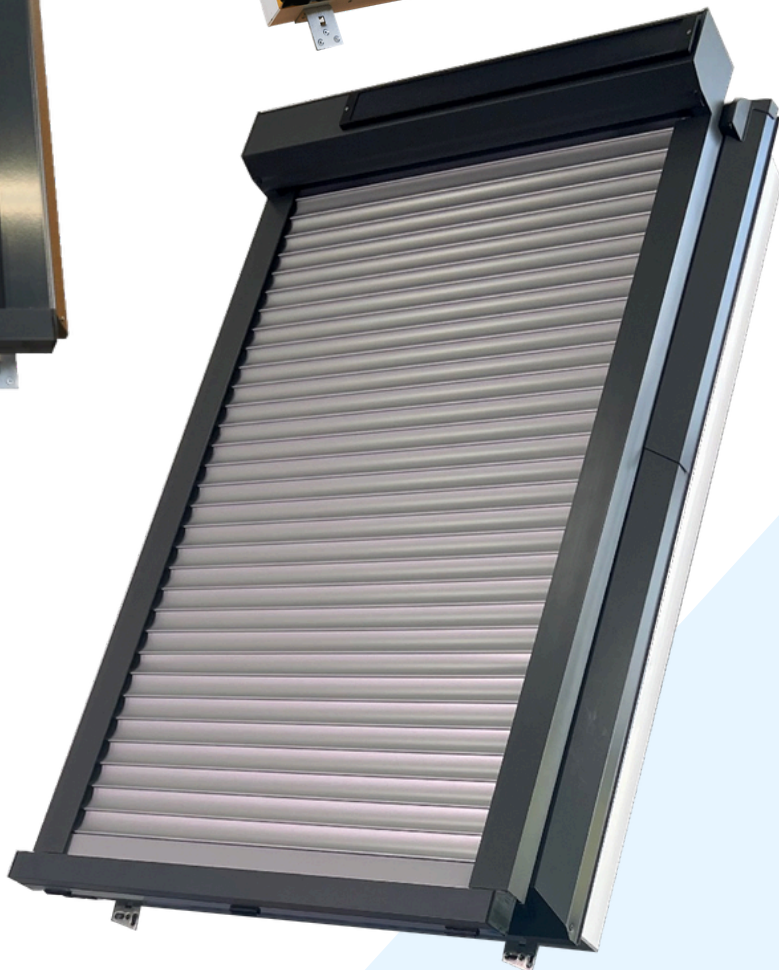

Standard armour colours:



External awnings to use with **SUPRO** and **SKYLIGHT** roof windows

The **SkyMAR** awning the perfect complement to **SUPRO** and **SKYLIGHT** windows. It provides optimal shading and protection all year round.

In summer it protects against overheating, in winter it prevents heat loss. It dampens rain noise and acts as a weather screen, further increasing thermal insulation.

In addition, the **SkyMAR** external awning provides adequate privacy in your attic.



Key features of SkyMAR awnings:

- **manual control**
- **control rod option** (control rod at extra cost as per price list)
- **construction colour** AL: RAL 8019, 7043 (brown, anthracite)
- **top profile:** AL folded,
- **bottom profile:** AL extruded, diameter 8 mm
- AL winding roller, diameter 22 mm
- minimum width - **400 mm**, maximum width - **1200 mm**
- minimum height - **500 mm**, maximum height - **1600 mm**
- maximum surface area 1.9 m²
- there is always extra material on the winding roll, approximately + 20 cm in relation to the ordered height

SKYMAR EXTERNAL AWNINGS



Roof windows

Type	Skylight Economic	Skylight	Skylight Premium	Skylight Plus Termo	SUPRO Triple	SUPRO Triple Termo	SUPROALU
Window pane parameters:							
Glazing U-value [Ug]	1,1	1,1	1,1	1,1	0,5	0,5	0,7
Total thermal energy transfer [g]	0,64	0,64	0,64	0,64	0,53	0,53	0,53
Warm frame - TGI Spacer	no	no	no	yes	no	yes	yes
Acoustic properties [dB]	n/a	30(-1;-4)	30(-1;-4)	31(-2;-5)	32(-1;-5)	32(-1;-5)	32(-1;-5)
Window parameters:							
Thermal transmittance [Uw] (W/m ² K)	1,4	1,4	1,4	1,3	1,1	0,93	1,0
Waterproof class	E1200	E1050	E1200	E1200	E1200 75° E750 15°	E1200 75° E750 15°	E1200 80° E1050 30° 9A 15°
Air permeability	Class 4	Class 3	Class 4	Class 3	Class 4	Class 4	Class 4
Snow load resistance	4H/Ar-20/4	4H-16-4T	4H-16-4T	4H/Ar-20/4	4H/Ar18/4/Ar18/4	4H/18TGI Ar/4/18TGI Ar/4	4H/12/4/12/4T
Profile geometry	straight	straight	rounded	straight	straight	straight	rounded
Number of gaskets	4	4	4	4	4	4	3

Roof hatches

Type	Skylight Loft	Skylight Loft Termo	Skylight Loft Plus Termo	SUPRO Loft Triple	SUPRO Loft Triple Termo
Window pane parameters:					
Glazing U-value [Ug]	1,1	1,0	1,1	0,5	0,5
Total thermal energy transfer [g]	0,64	0,5	0,64	0,53	0,53
Warm frame - TGI Spacer	no	yes	yes	no	yes
Acoustic properties [dB]	30(-1;-4)	30(-1;-4)	31(-2;-5)	32(-1;-5)	32(-1;-5)
Window parameters:					
Thermal transmittance [Uw] (W/m ² K)	1,8	1,4	1,4	1,2	1,1
Waterproof class	E1200	E1200	E1200	E1200	E1200
Air permeability	Class 4	Class 4	Class 3	Class 4	Class 4
Snow load resistance	4H-16-4T	4H-16-4T	4H/Ar-20/4	4H/Ar 18/4/Ar 18/4	4H/18TGI Ar/4/18TGI Ar/4
Profile geometry	straight	rounded	straight	rounded	straight
Number of gaskets	3	3	3	3	3

Warranty

15 Years

- Toughened outer glass
- Glass package broken due to hailstorm

10 Years

- Glazing package in case of loss of airtightness
- PVC components
- Fittings
- Construction and manufacturing defects

5 Years

- Sealing flanges and gaskets

2 Years

- Exterior roller shutters
- Interior roller blinds
- Awnings
- Actuators
- Electric motors
- All other accessories



SKYFENS sp. z o.o.

ROOF WINDOW FACTORY

Vetterów 7, 20-277 Lublin

SALES:

(POLAND) tel: +48 795 527 710

(GERMANY) tel: +48 795 527 792

(EUROPE) tel: +48 880 765 368

Authorised distributor:



©2026 SKYFENS sp. z o.o. All rights reserved. Neither part of this document may be copied or distributed for any purpose whatsoever without the written authorisation of SKYFENS. We reserve the right to typing mistakes, human errors and technical changes. The product photos may also include additional equipment